

INSTALLATION MANUAL

Thanks for purchasing this photoelectric intrusion detector, please read this instruction manual carefully before installation, and keep it for future reference.

	WARNING Never attempt to disassemble or repair the product. It may cause fire or damage to the devices. Do not use the product for purposes other than the detection of moving objects such as people and vehicles. Do not use the product to activate a shutter, etc., which may cause an accident. Do not touch the unit base or power terminals of the product with a wet hand (do not touch when the product is wet with rain, etc.). It may cause electric shock.
	CAUTION Do not exceed the voltage or current rating specified for any of the terminals during installation, doing so may cause fire or damage to the devices. Do not pour water over the product with a bucket, hose, etc. The water may enter, which may cause damage to the devices. Failure to follow the instructions provided with this indication and improper handling may cause injury and/or property damage. Clean and check the product periodically for safe use. If any problem is found, do not attempt to use the product as it is and have the product repaired by a professional engineer or electrician.
	NOTE These units are designed to detect an intruder and activate an alarm control panel. Being only a part of a complete system, we cannot accept responsibility for any damages or other consequences resulting from an intrusion.

1. FEATURES

- ◆ Beam interruption time adjustable
- ◆ Form C relay providing more applications
- ◆ Tamper switch
- ◆ Selectable beam frequency, suitable for long distance and stack use (Frequency adjustment type)
- ◆ LED digital tube display received signal strength, easy to debug (Frequency adjustment type)
- ◆ Wide voltage and energy saving design
- ◆ Digital communication function
- ◆ Alignment angle $\pm 90^\circ$ horizontally, $\pm 10^\circ$ vertically
- ◆ Digital filtering, environment adaptive function, minimum false alarm
- ◆ The lowest beam interference, can be used in all kinds of complicated environment

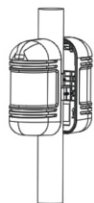

2. PARTS IDENTIFICATION

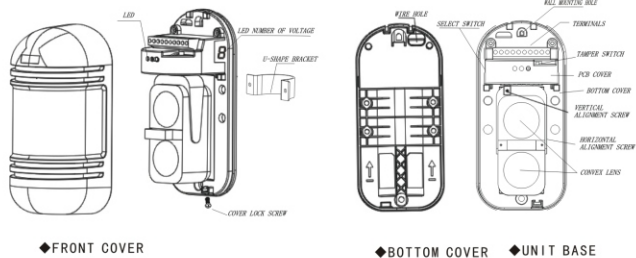

3. PRECAUTIONS

1) Please avoid these situations below to assure performance!

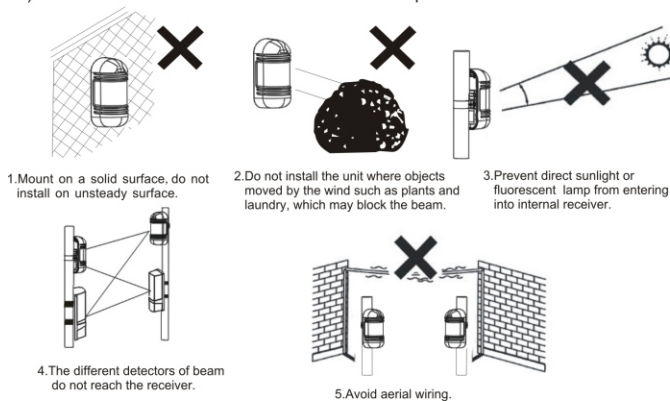

2) General installation

◆ INSTALLATION HEIGHT

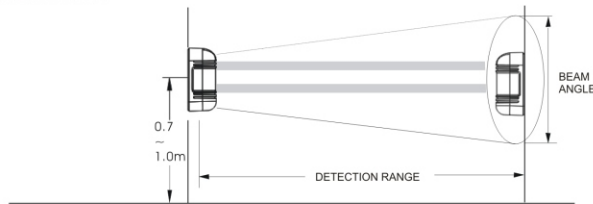

◆ ALIGNMENT ANGLE

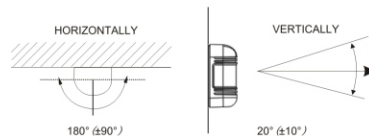

4. INSTALLATION METHOD

◆ WALL MOUNTING

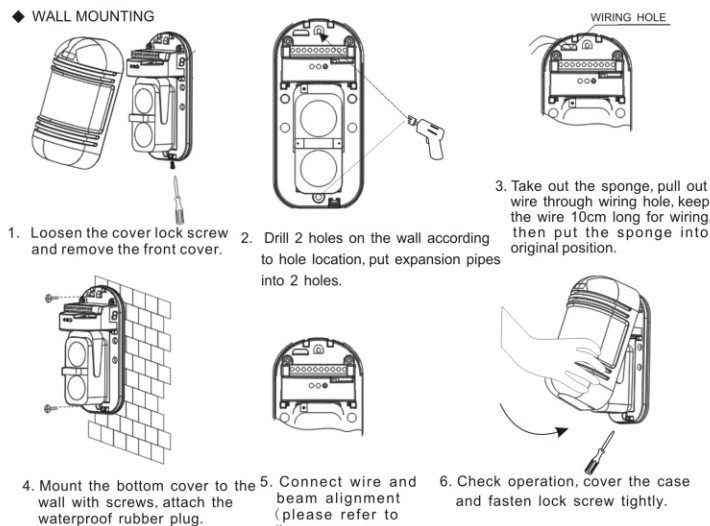

◆ POLE MOUNTING

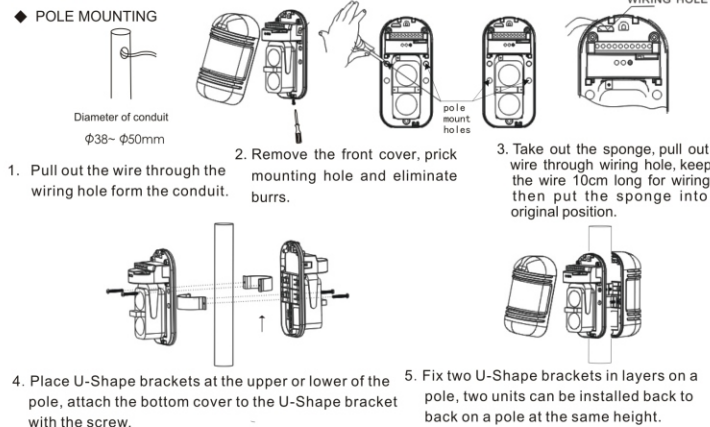

5. TERMINALS

WARNING Do not exceed the voltage or current rating specified for any of the terminals during installation, doing so might cause fire or damage to the devices.

>> TRANSMITTER

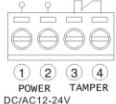

1. Power input: DC/AC12-24V;
2. Tamper switch is independent to other circuit, opens when cover is removed.

>> RECEIVER

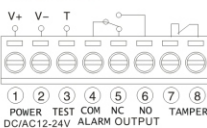

1. Power input: DC/AC12-24V;
2. Relay contact 1C DC 24V 0.5A max
3. 2, 3 as testing terminals, only provided as auxiliary test, 1.2V after calibrating;
4. Tamper switch is independent to other circuit, opens when cover is removed.

6. INSTANCE OF WIRING

1. WIRING OF 1 SET

The power of the transmitter and receiver are paralleled connection, using DC 12V by control panel, alarm output is NC as below:

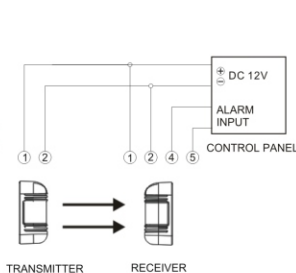

2. WIRING OF 2 SETS STACKING

The power of the transmitter and receiver are paralleled connection, using DC 12V by control panel, alarm output is NC and cascade as below:

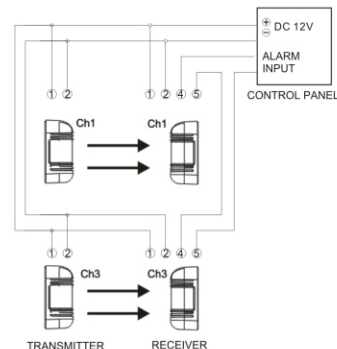

3. 2 SETS OF CONCATENATED INSTALLATION

The power of the transmitter and receiver are paralleled connection, using DC 12V by control panel, alarm output is NC and cascade as below.

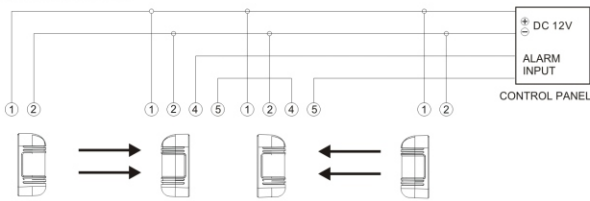

TRANSMITTER REVERSE RECEIVER TRANSMITTER **CAUTION**

Power wires should not exceed the following length.

Size	Length	DC 12V	DC 24V
0.5mm ² (Φ0.8)		40m	500m
0.75mm ² (Φ1.0)		60m	750m
1.0mm ² (Φ1.2)		80m	1000m
1.5mm ² (Φ1.4)		100m	1250m

- Power wires can not exceed the listed length.
- When connect more than one units, the needed wires length is obtained by listed length divided by number of units used.
- Do not connect terminals to exceed voltage specified, doing so might damage devices or cause fire.

8. DIP Switch

DIP Switch instructions (on the left of the PCB cover as below)

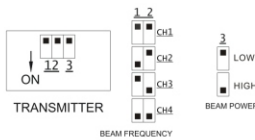

- 1 and 2 as DIP Switch, which is used for setting beam frequency, make sure they are on the same position with DIP Switch of receiver (Frequency adjustment type).
- The transmitter beam power has two grades: low and high, set by alarm distance.
- 1 and 2 as DIP Switch, which is used for setting beam frequency, make sure they are on the same position with DIP Switch of transmitter (Frequency adjustment type).
- Choose interruption time according to using place. Each interruption time set as the maximum detectable time. Faster speeds may be not detected. About birds, newspaper, leaves etc, they can interrupt beam occasionally, setting longer interruption time. After adjusting interruption time, verify is needed.
- To adapt to different application, alarm time can be chosen 3 seconds and 1 second, 1 second can be considered as immediately alarm.

9. BEAM FREQUENCIES (Frequency adjustment type)

The selectable beam frequency can be used to avoid unwanted crosstalk that can occur when using multiple beam detectors for long distance or stacking applications. Make sure The transmitter and receiver are facing to each other are set to the same code.

Although there are 4 separate beam frequencies can be chosen, please set frequency two channels apart for stacking applications. The upper unit is set on channel 1 while the lower is on channel 3, channel 2 and 4 are the same.

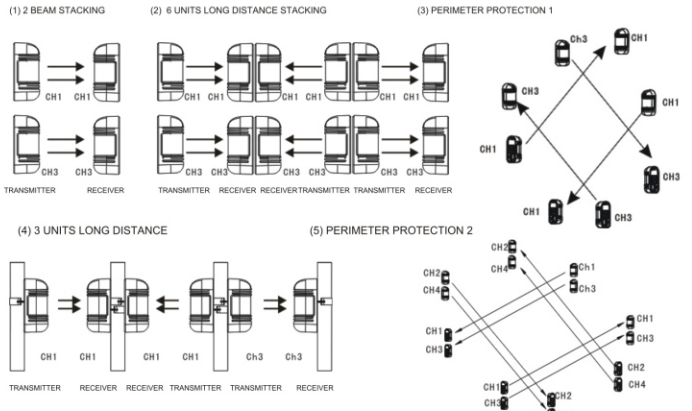

7. OPTICAL AXIS CALIBRATION LED DIGITAL TUBE VOLTAGE INDICATION

LED digital tube indication (on the right of the PCB cover as below) (Frequency adjustment type)

- Adjust beam frequency DIP switch, make sure transmitter and receiver set to the same frequency. For example, the transmitter set to frequency CH1, the receiver must set to frequency CH1 (Frequency adjustment type).
- Adjust top and bottom angle adjusting screw and horizontal bracket, see the receiver from transmitter optical sight and position it in the center of sight.
- Adjust top and bottom angle adjusting screw and horizontal bracket, see the transmitter from receiver optical sight and position it in the center of sight. At this time LED digital tube display from 0 to 9. "0" means there is no signal, and in the state of alarm, alarm indicator is on. Optical axis calibration, LED digital tube display "9" After the alignment, the voltage for terminal 2 and 3 is above 1.2V.
- After finish the above steps, must do walk testing and confirm the alarm status as normal. If can't calibrate, please do the first step. If still can't calibrate repeatedly, please refer to "11. TROUBLE HANDLING".

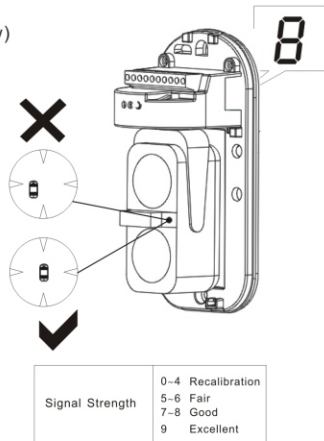

10. WALK TEST

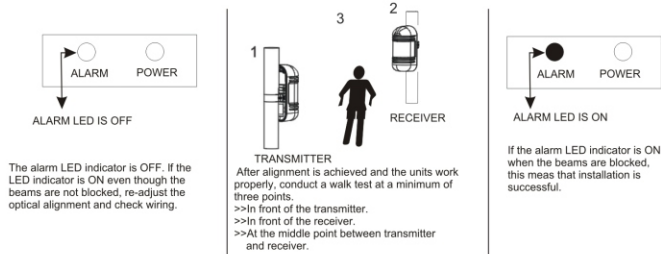

NOTE: If the ALARM LED indicator is OFF even though the beams are completely blocked, please refer to "11. TROUBLE HANDLING".

11. TROUBLE HANDLING

Trouble	Reason	Countermeasure
The indicator light is not on after powered on	Power wire have no voltage, open or short circuit, wrong polarity, beyond the prescribed voltage or power wire length.	Check power adapter, circuit, voltage polarity. Replace power adapter, power wire.
After beams blocked completely, alarm indicator is not on and without alarm output	1. Reflected or other transmitter light enter into receiver; 2. Beams are not interrupted at the same time; 3. Interrupting time set too long; 4. Wrong wiring for alarm output.	1. Remove reflected object or turn down other transmitter then calibrate again; 2. Make sure the beams are interrupted totally; 3. Reduce interrupting time; 4. Check receiver terminal and output circuit.
Although beams are not blocked, alarm indicator light is always on and with alarm output	1. Beams are not aligned, optical axis are not coincident; 2. There is obstacle between transmitter and receiver; 3. Frequency setting is not right; 4. The outer cover is very dirty, or covered by snow, frost, ice; 5. Transmitter not working.	1. Calibrate optical axis again; 2. Check the obstacle between transmitter and receiver; 3. Make sure the frequency between transmitter and receiver is the same; 4. Clean outer cover, use heater; 5. Check transmitter power supply, circuit and wiring.
False alarm	1. Wiring and power is not normal, wire corrosion; 2. There are moving obstacle such as birds, newspaper, leaves etc; 3. Installation base is not stable; 4. Optical axis are not aligned completely; 5. Transmit power set as L.	1. Check power supply, circuit and wiring; 2. Change mounting place; 3. Get rid of obstacle or change installation site; 4. Calibrate optical axis again; 5. Change transmit power to H.

NOTE: If trouble can not solved after the listed countermeasure, please contact us for technical support.

12. SPECIFICATIONS

Outdoor Alert Distance (m)	30	60	100
Indoor Alert Distance (m)	60	120	200
Detecting Method	Two infrared beams are interrupted at the same time		
Interruption Time	50ms, 100ms, 300ms, 700ms (optional)		
Beam Frequency	4 Channel		
Working Voltage	DC/AC 12-24V		
Working Current	90mA max		
Alarm Period	3s, 1s (optional)		
Alarm Output	Relay output 1C; Contact capacity: AC/DC 30V 0.5A max		
Tamper Switch	NC, opens when cover is removed		
IP Grade	IP55		
Working Temperature	-25°C~+55°C		
Environment Humidity	95% max		
Alignment Angle	Horizontal 180°(±90°); Vertical 90°(±10°)		
Mounting Place	Indoor/Outdoor, Wall/Pole		
Weight	1000g		

13. DIMENSIONS

